

ALUTUFF and ALUTUFF II



Brite White 824 • IR = .60



White 899 • IR = .54



Ivory 883 • IR = .62



Light Stone 887 • IR = .51



Tan 855 • IR = .38



Cocoa Brown 856 • IR = .20



Dark Brown 859 • IR = .16



Antique Bronze 854 • IR = .20



Caribbean Blue 881 • IR = .27



Gallery Blue 826 • IR = .12



Brick Red 898 • IR = .31



Brite Red 845 • IR = .28



Classic Burgundy 853 • IR = .19



Hickory Moss 870 • IR = .36



Patina Green 893 • IR = .38



Evergreen 875 • IR = .25



Light Gray 889 • IR = .31

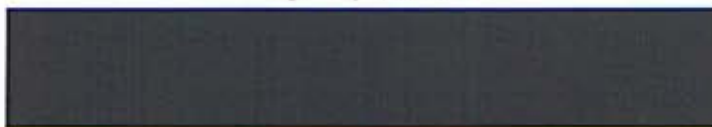

Charcoal Gray 851 • IR = .18



Black 880 • IR = .14



Hartford Green 821 • IR = .09

Colors are as actual as allowed by the printing process. • IR = Initial Reflectivity

Alutuff and Alutuff II ENDURACOTE™

PREMIUM DEFENSE
Against the Elements

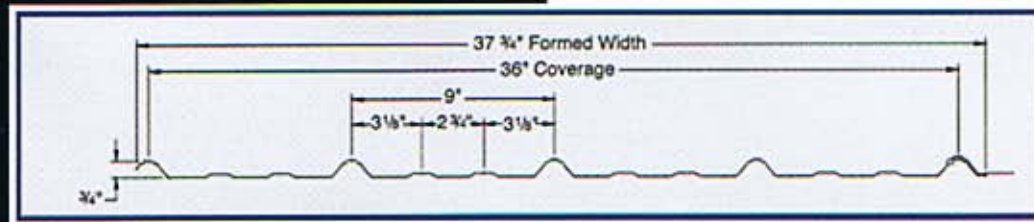

Alutuff and Alutuff II Panel Specifications

- 29 ga. structural quality, full-hard steel
- High quality prime metal
- Anti-siphon groove for optimum weathertightness
- UL 2218 Class 4 hail impact resistance
- UL 790 Class A fire resistance rating
- Custom cut to lengths up to 40'

Alutuff Warranty

- Lifetime film integrity warranty for walls and roofs
- 30 year warranty against fade and chalk for walls and roofs
- 15 year edge rust warranty against acid rain
- 25 year non-perforation warranty against acid rain for walls; 20 years for roofs

Alutuff II Warranty

- Lifetime film integrity warranty for walls and roofs
- 30 year warranty against fade and chalk for walls and roofs
- 10 year edge rust warranty against acid rain

Alutuff and Alutuff II Panels are finished with Enduracote™, a high performance silicon-modified polyester paint system that offers unbeatable durability and superior long-term performance against the elements. Enduracote's™ protection ensures low maintenance, lasting beauty and outstanding value.

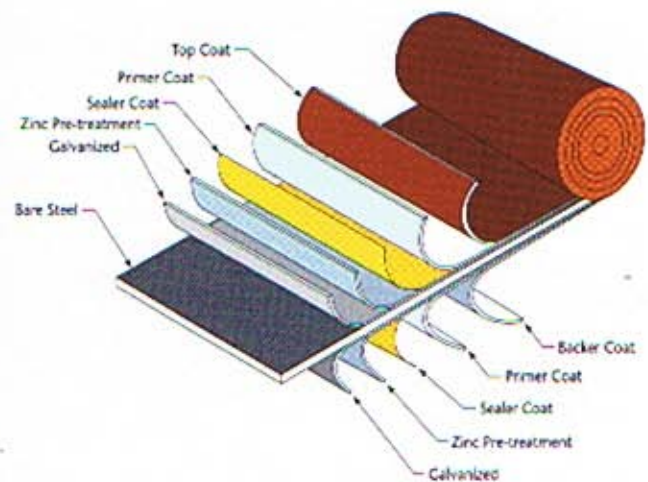

Facilities Nationwide
Corporate Office
3449 Hempland Rd.
Lancaster, PA 17601
(800) 477-2741

www.fabral.com

Valspar

F-525B
98-32-481
2/06 50k DC

Specifications and colors subject to change without notice or obligation to make changes in products previously purchased. Actual metal samples are available.